



REMBE® ALLIANCE

**Continuous Excellence
in Safety and Control**



**Engineered
and Manufactured
in Germany**



ABOUT US...

In 1973 REMBE® was founded by Bernhard Penno. In addition to the core business of bursting discs for the chemical and process industries we started business in the field of measurement technology in 1978. Since 1988 REMBE® have continuously increased its export activities. Today we are represented globally in more than 70 countries, and have dedicated REMBE® facilities in the key industrial areas. Still a family owned and privately run business REMBE® are able to provide fast, efficient and reliable solutions.

Fact Box

Headquarter:	59929 Brilon / Germany
REMBE®	REMBE®, INC., Charlotte, NC / USA
Satellites:	REMBE® LTD, London / UK REMBE® Meß- und Regeltechnik GmbH, Brunn / Austria REMBE® S.R.L., Milan / Italy REMBE® OY, Helsinki / Finland REMBE® JLT Branch, Dubai / UAE REMBE® ASIA PACIFIC PTE. LTD., Singapore REMBE® CHINA LTD, Shanghai / China
Affiliated companies:	REMBE® FIBRE FORCE GMBH, Brilon / Germany KERSTING GMBH SAMPLING + GROUNDING, Brilon / Germany
Employees:	110+
Product range:	A comprehensive range of bursting discs and breather valves for all pressure and vacuum relief applications in any process industry, explosion protection systems & solutions, controller- and evaluation units, flow metering systems, special sensors, grounding- and sampling systems
Production:	REMBE® keeps a high degree of vertical integration with an extraordinary quality level. Latest laser, welding, precision tool production technologies guarantee quick and precise manufacture. Independently, whether custom-made or large batches manufacture: Competitive lead-times and inherent quality.
Industries served:	Renewable Energies, Geothermal, Pulp & Paper, Biotech, Cosmetic, Food & Beverage, Animal Food, Aerospace, Raw material conveying, Chemical, Pharmaceutical, Petrochemical, Offshore, Construction, Oil & Gas, Water & Sewage, Transport, Infrastructure
Market leadership thru:	Technology, Innovation, Quality, Fast Response, Service
Wettbewerbsvorteile für den Kunden:	Schnelligkeit: Wir sorgen dafür, dass Ihre Anlage pünktlich anläuft! Ehrlichkeit: Erhöhung Ihrer Anlagenperformance durch die richtige Produktauswahl
Manufacturing in Accordance with / Meeting the following Codes:	ISO 9001: 2008, ASME Sec. VIII, Div. 1, KTA 1401, GOST-RTN,-TR (Russia), Gaspromnadzor (Belarus), China Man. Licence (CML), KOSHA (South Korea), NFPA, ATEX 114 Directive 94/9/EC, PED, CSA, GL, KNOWN CONSIGNOR (DE/KC/00912-01/0218)
Services:	Consulting for plant safety and process optimisation, insurance cover, financing, maintenance

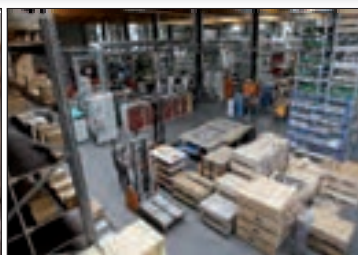

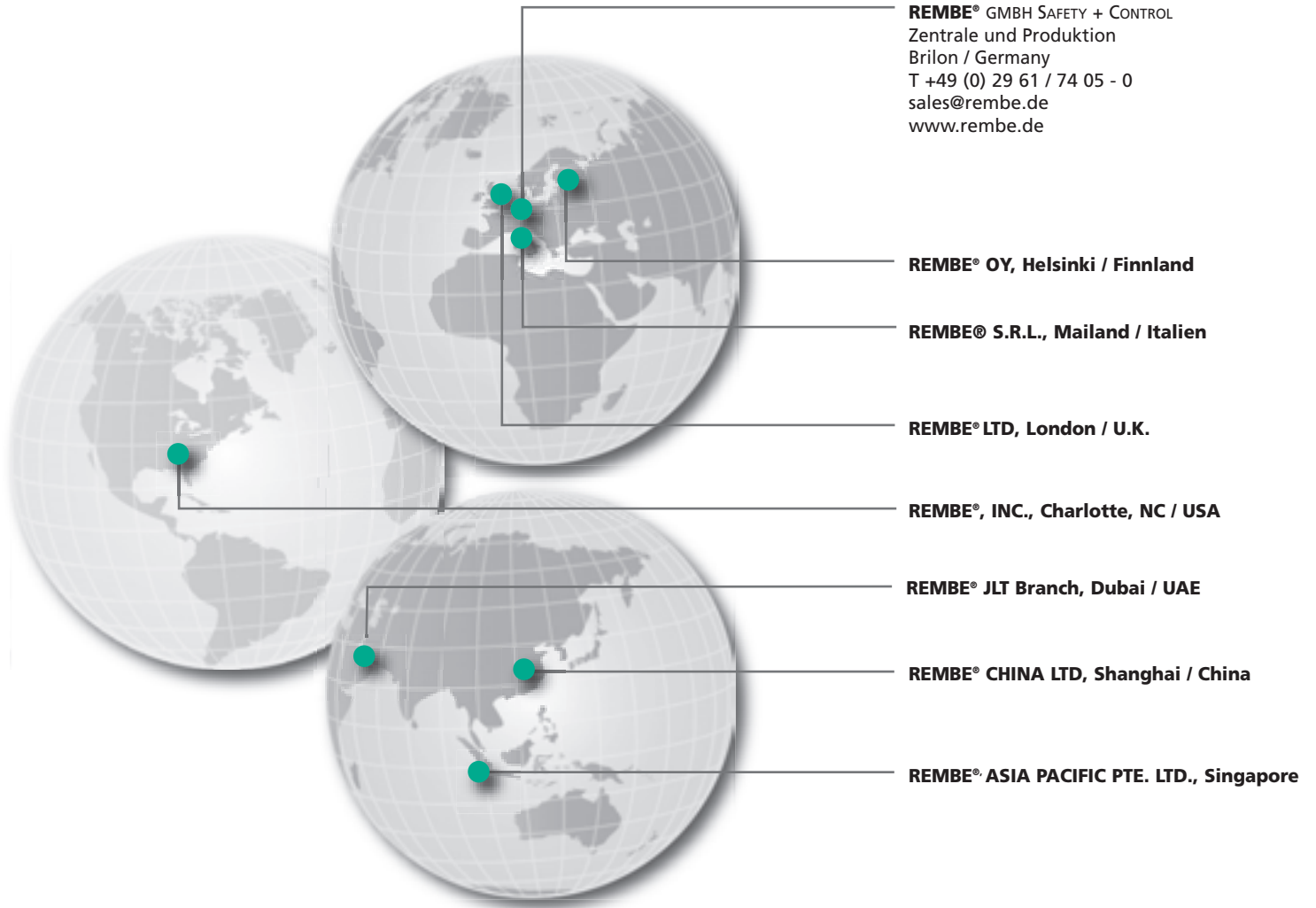



REMBE® ALLIANCE



REMBE® GMBH
SAFETY+CONTROL

STRUCTURE OF DIVISIONS

SAFETY DIVISION: Products to protect your plant against Explosions, Pressure and Vacuum conditions. Bursting discs and breather valves provide process safety throughout your production facility. State of the art Flameless indoor explosion venting, explosion isolation or suppression protects your facility against dust explosions and dust explosion propagation. Extensive material stocks enable flexible production and fast response deliveries in most material grades. Premium deliveries are offered on application.

CONTROL DIVISION: Reliable flow measurement. Professional know-how, consulting and a wide production range provide a more transparent production process. The product portfolio comprises weighing systems for conveyors up to custom-made flow meters for bulk and solids. Our degreed engineers and technicians have long established referenced experience for complete solutions of weighing silos, mixers and tanks.

AFFILIATED COMPANIES



KERSTING GMBH
SAMPLING+GROUNDING

Your strong partner for explosion prevention and sampling. With their core competences in electrostatic grounding and sampling of bulks and liquids KERSTING has more than 10 years experience in these areas. Our strength is bespoke solutions for your individual applications.



REMBE®
FIBRE FORCE GMBH

The expert for innovative sensor technology. Since 2006, REMBE® FIBRE FORCE GMBH has developed, manufactured and marketed the latest sensor technology based on fibre optical and semiconductor physics. Unique customer requirements are satisfied by utilising this state of the art technology.



T A B L E O F C O N T E N T S

Pressure and Vacuum Relief

6

Intelligent Solutions for the Plant Safety

8

Conventional Explosion Venting with Explosion Panels

16

Flameless Explosion Venting / Explosion Isolation

18

Explosion Suppression / Explosion Protection for Conveyors

21

Flow Metering of Bulk & Solids

22

Wireless Measurement of Forces, Weights, Axles

26

Electrostatic Grounding / Sampling

28

Monitoring of Screws / Screw Connections / Sealings

32

Access Control

34

Pressure and Vacuum Relief



Orhan Karagöz
Business Development Director
Product Manager ELEVENT®
orhan.karagoez@rembe.de
T +49 (0) 29 61 / 74 05 - 110
...since 1990 at REMBE®



Gerd Mayer
President REMBE®, INC.
Charlotte, NC / U.S.A.
gerd.mayer@rembe.us
T +1 (704) 716 7022
...since 2006 at REMBE®, INC.



Kwan Kum Nyin
Sales Director
REMBE® ASIA PACIFIC PTE. LTD.
kwankn@rembe.com
T + 65 674 981 65
...since 2011 at REMBE®



Rebecca Chan
Sales Manager
REMBE® ASIA PACIFIC PTE. LTD.
rebecca.chan@rembe.sg
T + 65 6742 8344
...since 2012 at REMBE®





BT-bursting disc with holder unit

Domed, conventional bursting disc **BT**

Domed bursting disc type BT is mainly used for applications with middle and high burst pressures. The burst pressure is determined by the tensile strength and the thickness of the tension loaded metal membrane. The maximum permissible operating pressure for BT bursting disc is up to 70 % of the specified burst pressure. For medium burst pressures, the bursting disc must be equipped with an integrated vacuum support in case of vacuum conditions. This protects the burst element from fatigue failure. While these 'fragmenting' style discs can be viewed as 'Old' technology they are still regularly used today and still offer a cost effective fit for purpose solution for simple applications.



BT-SKODV with signalling unit
SK and holder unit

Triple-section bursting disc **BT-ODV** for low and middle burst pressures

Triple-section bursting discs of type BT-ODV are mainly used for applications with low or medium burst pressures. The burst pressure is determined by the burst element with integrated breaking points and the sealing membrane. The highest precision at the response pressure is guaranteed. BT-ODV triple-section bursting discs are extremely reliable even under pulsating or changing pressure conditions as burst pressure and vacuum resistance are functionally dispersed.



BT-STAR with special
lasered breaking points

Star-shaped opening bursting disc **BT-STAR**

Forward acting STAR bursting disc is applicable for nearly all pressure ranges. The mainly triple-section design has a non-fragmenting star-shaped opening. Therefore this type can be installed upstream of safety valves.

In case of low burst pressures the STAR bursting disc is fitted with a corrosion-resistant Teflon membrane.

Diffusion-free metal membranes have the function of sealing whenever middle to high burst pressures are concerned. Due to the multi-layer design the pressure determining burst element is on the corrosionprotected venting side. Operating ratio of the BT Star is up to 80 %.



Intelligent Solutions for the Plant Safety



Georg Vonnahme
Senior Sales Engineer /
Manager Replacement Business
georg.vonnahme@rembe.de
T +49 (0) 29 61 / 74 05 - 111
...since 1981 at REMBE®



Michael M. MacClancy
Managing Director
London / U.K.
michael.macclancy@rembe.co.uk
T +44 (0) 207 630 03 64
...since 2009 at REMBE® LTD



Graeme Melrose
Sales Engineering Consultant
graeme.melrose@rembe.co.uk
T + 44 191 267 2935
...since 2013 at REMBE® LTD



Helen Sztarkman
Sales Manager New Markets
Charlotte, NC / USA
helen.sztarkman@rembe.us
T + 1 (704) 716 7022
...since 2009 at REMBE®, INC.



Bursting discs for ANY OEM application



The standard product range is continuously developed in order to provide new bursting disc units for advanced requirements. Reliable pressure relief at a predetermined pressure is guaranteed. Whenever space, weight, gas density or special installation requirements are important, our experienced design and sales engineers can engineer a solution to whatever your requirement. The bursting disc units are suitable for applications in aerospace, hydraulic, cryogenic, pharmaceutical, medical technology industries and others, where compact protection against pressure combined with easy handling is essential. In case of high leakage requirements and use of delicate membranes the bursting discs are micro welded. The result is a robust unit with simple installation routines.



Compact bursting disc **UKB-LS**

The burst element is micro welded gas-tight in a housing. Manufacture is always made according to customer's specifications. Bespoke designs whatever your requirements are available.

The robust bursting discs offer maximum leak-tight and vacuum resistant integrity. The bursting disc is unaffected by heavy cyclic pressures and provide an operating ratio up to 90 %. They are also immune to significant back pressures.

Laser-welded bursting discs
in special housings

Bursting Disc for Low Pressures **IKB®-LP**

The fully-metallic low pressure bursting disc IKB®-LP has been particularly developed for low pressure applications < 0.5 barg (15 psig) avoiding the compliance of PED directive and ASME code Sec. VIII, Div. 1. Its manufacture is based on the innovative and patented IP US Pat. 7,520,153 technology. The IKB®-LP bursting disc with its aseptic design provides a burst pressure up to 90 % and largest vent areas. It withstands full vacuum and is resistant against pressure cycles. Standard materials are ss316 (L) and Hastelloy C276. Installation is made easily and torque independent between all standard flange connections.

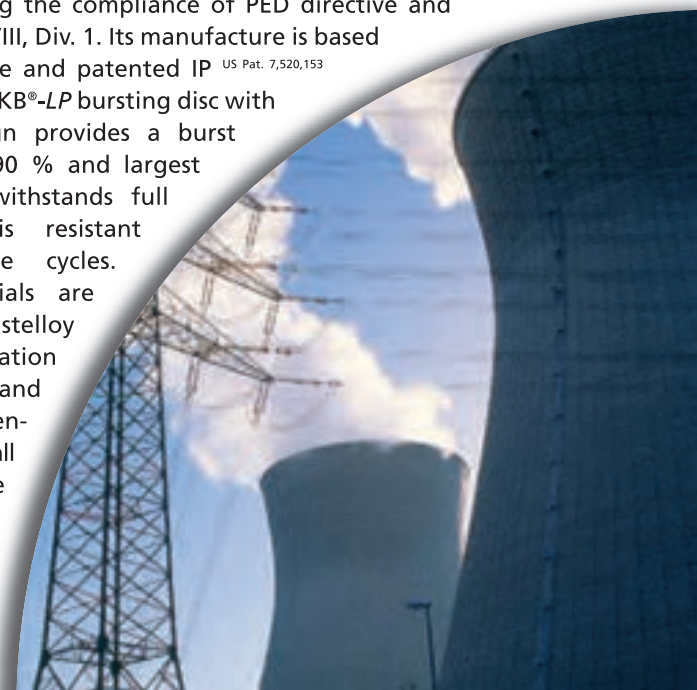

New Better Industry Standard



Nina De Luca
Sales Assistant
Process Safety Department
nina.deluca@rembe.de
T +49 (0) 29 61 / 74 05 - 127
...since 2008 at REMBE®



Carina Wegener
Sales Engineer
Process Safety Department
carina.wegener@rembe.de
T +49 (0) 29 61 / 74 05 - 128
...since 2012 at REMBE®



June Karagöz
Managing Director
REMBE® ASIA PACIFIC PTE. LTD.
june.karagoez@rembe.de
T +49 (0) 29 61 / 74 05 - 115
...since 2007 at REMBE®



Sabrina Bangert
Assistant to Business
Development Director
sabrina.bangert@rembe.de
T +49 (0) 29 61 / 74 05 - 125
...since 2007 at REMBE®



IP Technology and Kinetics makes the fastest Bursting Disc **IKB®**

The patented IP ^{U.S. Pat. 7,520,153} technology enables the REMBE® Engineers to introduce a defined amount of kinetic Energy in the IKB® Disc. When reaching the burst pressure, the IKB® immediately releases this Energy and gives full bore opening instantaneously.

The beauty with this revolutionary Design is that preweakening Scores or additional Knives downstream are no longer necessary to guarantee a secure and full relief.

All these supporting measures are now incorporated in the dome of the Disc: invisible, so-called imperfect and accelerated by Kinetics = the perfect Bursting Disc!

Operators from the following Industries are already successfully using the IKB® to protect their Process Equipment against excessive Overpressure:

- Chemical and Petrochemical (Containers, Pipework, Vessels)
- Food, Pharma and Biotechnology (sterile Containments, Blenders, Mixers)
- Special Machine and Equipment Manufacturing



Below listed Features made our Customers to switch from Conventional Scored Discs to the **IKB®**

1. Universal installation scheme: From 3/4" to 6" (DN 20 to DN 150)
2. Unbelievable Pressure Range with just one Disc Design: PSI
3. Individual Material Selection meets all Lifetime and Performance demands
4. Full Temperature spectrum from -385 °F to 1,112 °F (-196 °C to +600 °C)
5. Smooth Process Surface allows easy CIP / SIP
6. 100% relief capacity - ultimate Safety at reasonable Cost
7. Operating factor up to 90% enables Operators to maximize Process Output
8. Resistant against harsh Pressure Cycles, Vacuum or excessive Torque
9. Dual use for Gases And Liquids*
10. Flexible fixing Installation in REMBE®'s IG-KUB® Holder unit

* Requires Air Cushion



Thomas Münstermann
Head of Process Safety Department
Product Manager KUB®
thomas.muenstermann@rembe.de
T +49 (0) 29 61 / 74 05 - 113
...since 1998 at REMBE®



André Schultze
Sales Assistant
Projects + Expansion Department
andre.schultze@rembe.de
T +49 (0) 29 61 / 74 05 - 451
...since 2012 at REMBE®



Francesco Petruzzelli
Sales Manager
francesco.petruzzelli@rembe.it
T +39 02 62 03 30 57
...since 1997 sales of
REMBE® products in Italy



Andreas Hansen
Sales Manager
andreas.hansen@rembe.it
T +39 02 62 03 30 57
...since 1986 sales of
REMBE® products in Italy

» Any Application « Bursting Disc

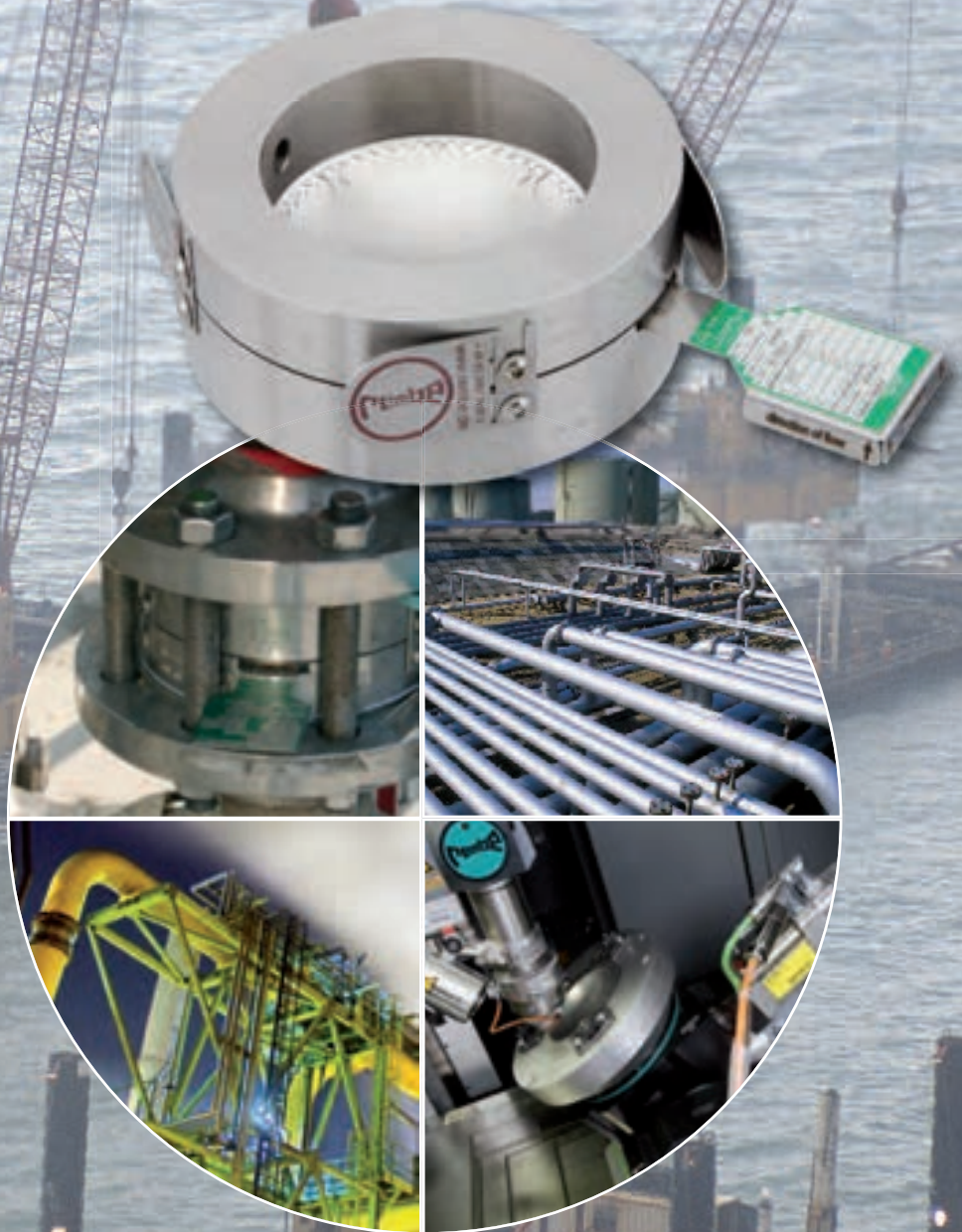

KUB® with cut-away holder unit



KUB® bursting disc

KUB®

reverse acting buckling pin bursting disc

This patented KUB® is unique in using the buckling pin principle according to Euler's formula. No other bursting disc has ever provided such indisputable benefits as the KUB® even under extreme working conditions (operating ratio up to 98 % of burst rating). Tolerances with less than ± 2 % for special applications are possible. Due to the totally "clean" upstream (process) side, this bursting disc offers the ideal solutions for aseptic and sanitary applications and demanding CIP/SIP procedures. It is suitable for any media: gas, vapour, liquid, 2-phase flow.

The KUB® offers unbeatable cycling capability, absolute guaranteed vacuum resistance and non-fragmenting design. The simplified leak-tight installation is totally torque-independent. At lower pressures the KUB® can also be installed directly between companion flanges (without a disc holder). The short and long-term customer benefits are indisputable.



KUB®-V-Series
with volution-unit
for In-Situ-testing
of safety relief valves

KUB®-V-Series

for safety relief valve isolation

Enables In-Situ relief valve testing without process system disruption. The benefit of the KUB®-V-Series is ingenious: by putting the space between disc and safety valve slowly under pressure, the valve can be checked in situ for leakage or smooth performance. This unique durability against backpressure of the KUB®-V-Series is achieved by modifying the proven double-layer KUB® design and will never be obtained by single-layer or pre-weakened bursting discs.

KUB®-G-Series

for geothermal applications

Yet another highlight of the KUB® family of discs: Is the world's first ever bursting disc tailored to the challenging demands of geothermal power plant applications. For these applications the endurance of a bursting disc is defined by extreme temperatures and ongoing corrosion. Special finishing technologies of the KUB®-G-Series withstand these aggressive effects and doubles the lifetime of the bursting disc compared with conventional scored bursting discs.



KUB®-G-Series
for geothermal applications after response



TC(R)-KUB® for aseptic and sanitary applications

The TC(R)-KUB® bursting disc has been developed specifically for pressure protection under aseptic and sterile conditions, e.g. in the pharmaceutical, biotechnical and food industries.

This bursting disc has a smooth convex surface on the process side which guarantees safe sterility. The especially stable and robust construction provides a safe and easy installation, with unparalleled cycling capability.

Due to the integration of the KUB® into a clamp sealing ring, the bursting disc can now be installed into standard clamp pipe connections. The TCR-KUB® is fitted with an integrated PTFE-gasket (FDA conformity and USPS Class VI) that can be renewed on demand.



TCR-KUB®
with clamp and pipe connections

Two-way bursting disc ZW for protection from pressure and vacuum

The proven operating principles of the triple-section bursting discs ODV and KUB® are integrated in one system.

The bidirectional-acting bursting disc ZW takes over the function of two bursting discs, but only requires one point of installation. It protects in one direction against inadmissible pressure and in the opposite direction against inadmissible vacuum.

This maintenance-free bursting disc type opens in both directions. It opens at low response pressure and is suitable for liquid and gaseous media.

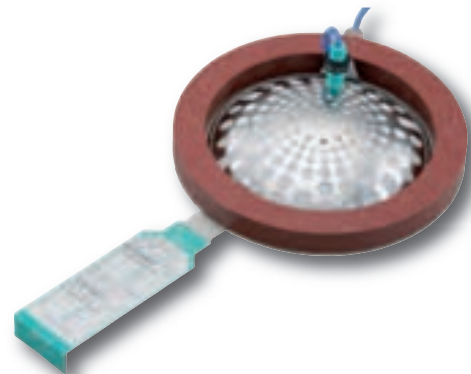

ZW-bursting disc with monitoring unit

Breather valve ELEVENT® for tank protection

The unique ELEVENT® valve design with deep-drawn full stainless steel/metal housing, modular assembly as well as interchangeable components, offers an optimised protection for applications with low opening set pressures from 2 mbar to 200 mbar (0.3 psig to 2.0 psig). This conservation vent protects stored product from contamination, evaporation and potential explosive scenarios. The modular construction offers easy assembly and disassembly by means of a clamped body. The ELEVENT® is an ideal solution particularly in hygienic/sterile applications.



Breather valves
for tank protection

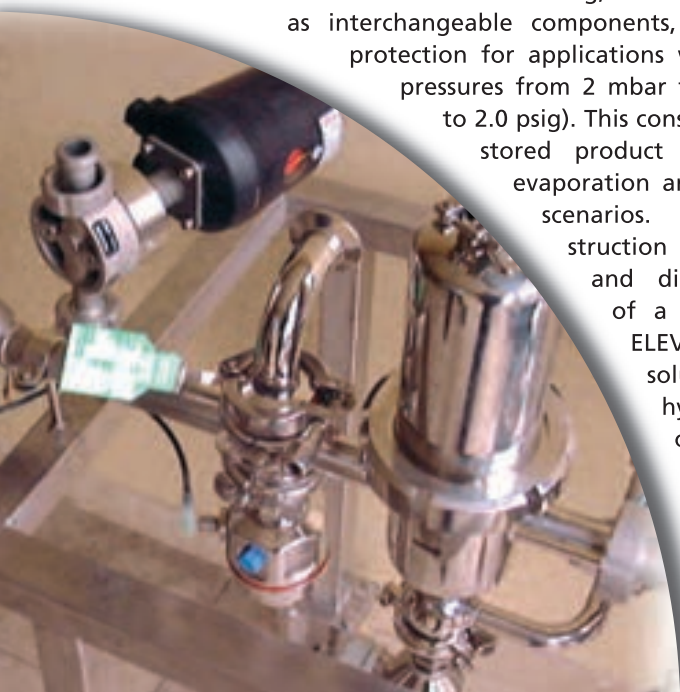



BIRD Signalling

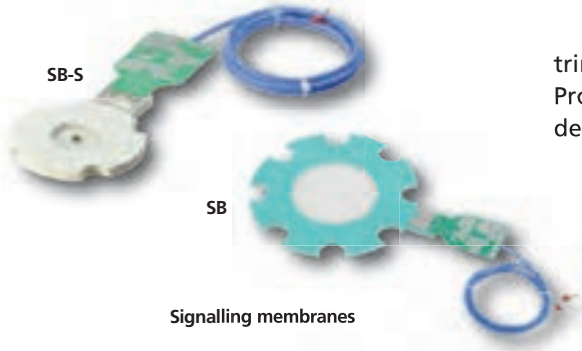

Signalling membranes



Fibre optical signalling membrane FOS

Reliable monitoring of bursting discs with **Signalling** Units

Signalling units are used if difficult to access bursting disc installations do not allow a visual inspection or if data are directly transferred to a PCS. Leakages and bursting disc response are monitored.

The complete process can be monitored by either using an intrinsically safe monitoring unit or a special signalling membrane. Proximity switches and wireless or long distance data transmission devices are also available.

Fibre optical signalling membrane **FOS**

In case of a bursting disc response, the new fibre optical signalling membrane generates an optical signal and takes it to the process monitoring unit via EMI (Electro Magnetic Interference) and high voltage insensitive fibre optical cables for evaluation.

In case of the signalling membrane being set in motion, the luminous flux is interrupted due to the tear of the optical fibre. The following fibre optical evaluation unit (FOA) immediately provides an electrical signal for optical or acoustic alert that can also be used for further data processing.

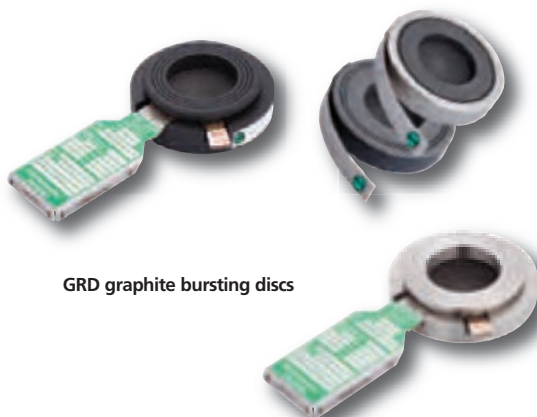

GRD graphite bursting discs

Graphite bursting disc **GRD** - for low and intermediate pressure and aggressive media

The GRD-series is perfectly suitable for corrosive and low pressure processes. Though low in cost, the GRD graphite disc offers a wide range of features such as the patented teflon-sintered design for ultimate protection or the two-way performance for bidirectional operation.

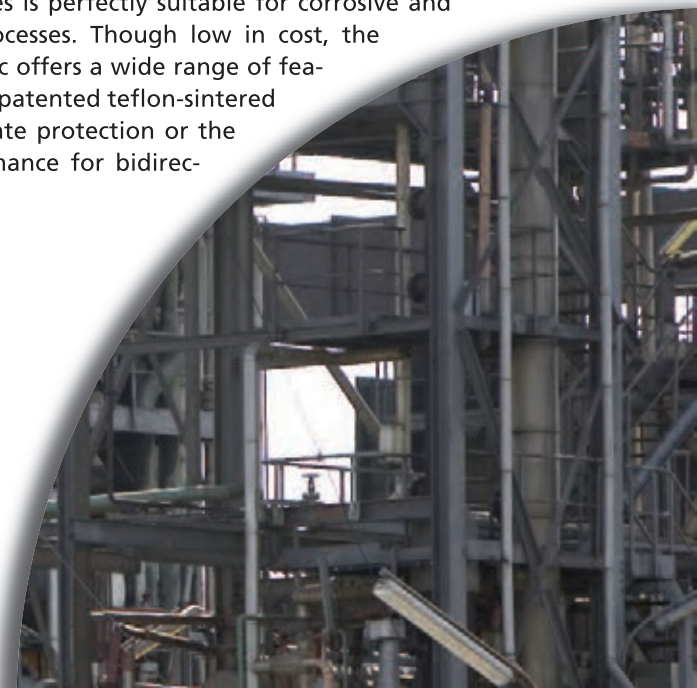

Conventional Explosion Venting with Explosion Panels



Sarah Brügger
Sales Assistant
Explosion Protection Department
sarah.bruegger@rembe.de
T +49 (0) 29 61 / 74 05 - 116
...since 2005 at REMBE®



Nadja Trubnikow
Sales Assistant
Explosion Protection Department
nadja.trubnikow@rembe.de
T + 49 (0) 29 61 / 74 05 - 123
...since 2008 at REMBE®



Mariana Becker
Sales Assistant
Explosion Protection /
Projects + Expansion Department
mariana.becker@rembe.de
T + 49 (0) 29 61 / 74 05 - 124
...since 2010 at REMBE®



Claire Lloyd
Business Development Europe
claire.lloyd@rembe.co.uk
T +44 (0) 191 469 88 56
...since 2012 at REMBE®





EX-GO-VENT

The EX-GO-VENT incorporating bionic structures guarantees extraordinary stability to suit most standard applications. Unlike other manufacturers' options, the EX-GO-VENT is NOT torque dependent during installation. Typically, mounting is directly made onto walls or round-shaped equipment, e. g. cyclones, filters, silos, etc.

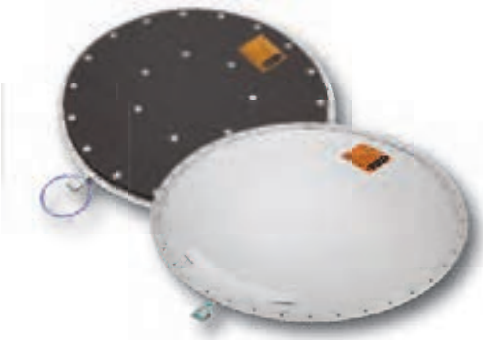

EX-GO-VENT-HYP

This flat bursting disc EX-GO-VENT-HYP has been especially developed for hygienically demanding applications found in the industries of food processing and pharmaceuticals. The smooth surfaces, in connection with the patented, full surface and tapered sealing concept, enable the implementation of these special bursting discs in previously critical plants such as spray-dryers with/without wet cleaning, fluidized bed dryers, filters and mixers. To ensure a wide-spread acceptance of the application in operational practice, the design of the EX-GO-VENT-HYP is based on the strict criteria of EHEDG (European Hygienic Engineering & Design Group).

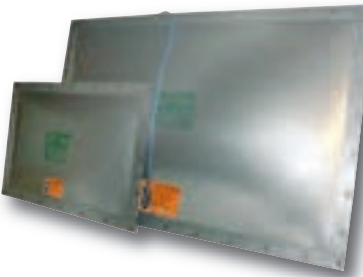

EDP

The single-layer EDP explosion panel is recommended for protection against fluctuating working pressures. The domed construction provides high stability up to a pressure of 80 %. The rated breaking points (Pat. No. EP 07 73 393) are integrated within the mounting frame. The domed construction also greatly reduces contamination. Sterility and cleaning is simplified (SIP/CIP Cleaning).

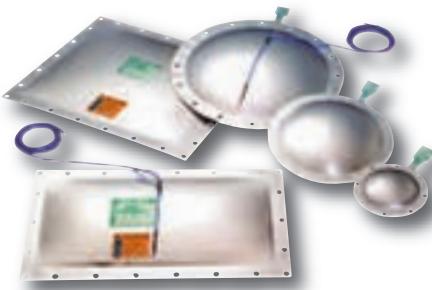

ODU / ODV

The domed triple-section burst discs are mainly used for applications with low or middle burst pressures and with the demand for a long, maintenance-free lifetime combined with large venting areas. ODVs are applied to working pressures up to 80 % of the specified burst pressure (80 % operating ratio). With more than 70 standard rectangular and round sizes, this burst disc design is the most all-purpose one. Effective venting areas from 0.05 m² up to 2 m² (77.5 sq inch up to 3,100 sq inch) per burst disc are available.

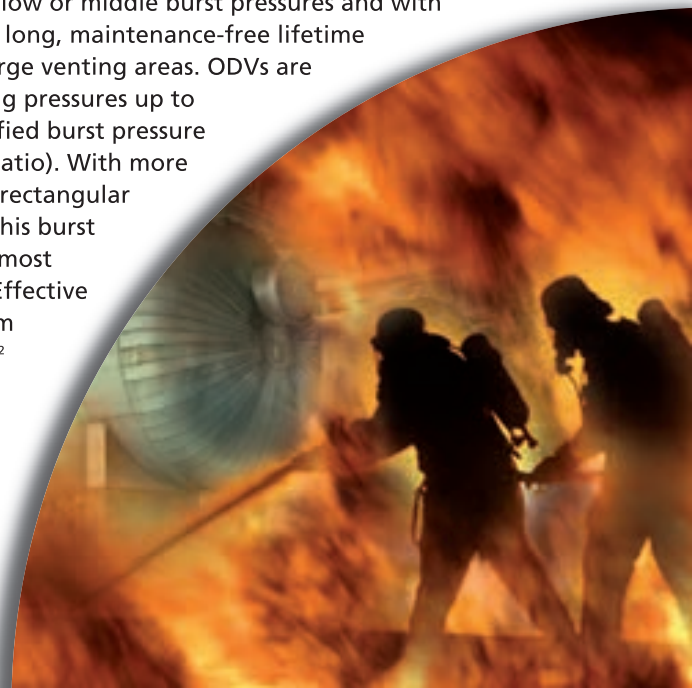



Roland Bunse
Head of Explosion Protection
Department / Product Manager
roland.bunse@rembe.de
T +49 (0) 29 61 / 74 05 - 112
...since 1994 at REMBE®



Klaus Meichle
Sales Engineer
Explosion Protection Department
klaus.meichle@rembe.de
T + 49 (0) 29 61 / 74 05 - 119
...since 2010 at REMBE®



Andre Häger
Project Engineer /
Product Manager
Explosion Protective Systems
epd@rembe.de
T +49 (0) 29 61 / 74 05 - 129
...since 2012 at REMBE®



Johannes Lottermann
Head of Projects + Expansion
Department
Senior Consultant
Explosion Protection
johannes.lottermann@rembe.de
T + 49 (0) 29 61 / 74 05 - 122
...since 2010 at REMBE®

Indoor Explosion Venting Systems with Flame Absorber and Dust Retainer



Q-Rohr®-3

The patented REMBE® Q-Rohr®-3 consists of a special stainless steel mesh construction and an integrated REMBE® bursting disc. An integrated controller keeps the plant personnel informed about full operation.

In case of emergency, flames are extinguished and pressure and noise are reduced to negligible levels. No burned or unburned dust passes through. Even the surface temperature (< 90° C / 194° F) is cooled down to a minimum.

**REMBE®
invented
Flameless
Venting**



NFPA Compliant

Pat.-Nos. DE 38 22 012
US 7,905,244

**Certified according to
EN 16009**



**The
Original**

Explosion venting with flame absorber

Flamebreaker **Q-Box II**

The Q-Box II flame-reduced explosion vent can be used to great effect either outdoors or indoors. When used indoors, it dispenses with the headaches of positioning complex, cumbersome and expensive vent ducting.

The Q-Box II provides low pressure resistance, effectively eliminating flame and heat emissions, and thereby allowing easy indoor installation and positioning of relevant machinery.



Q-Box II in two standard sizes

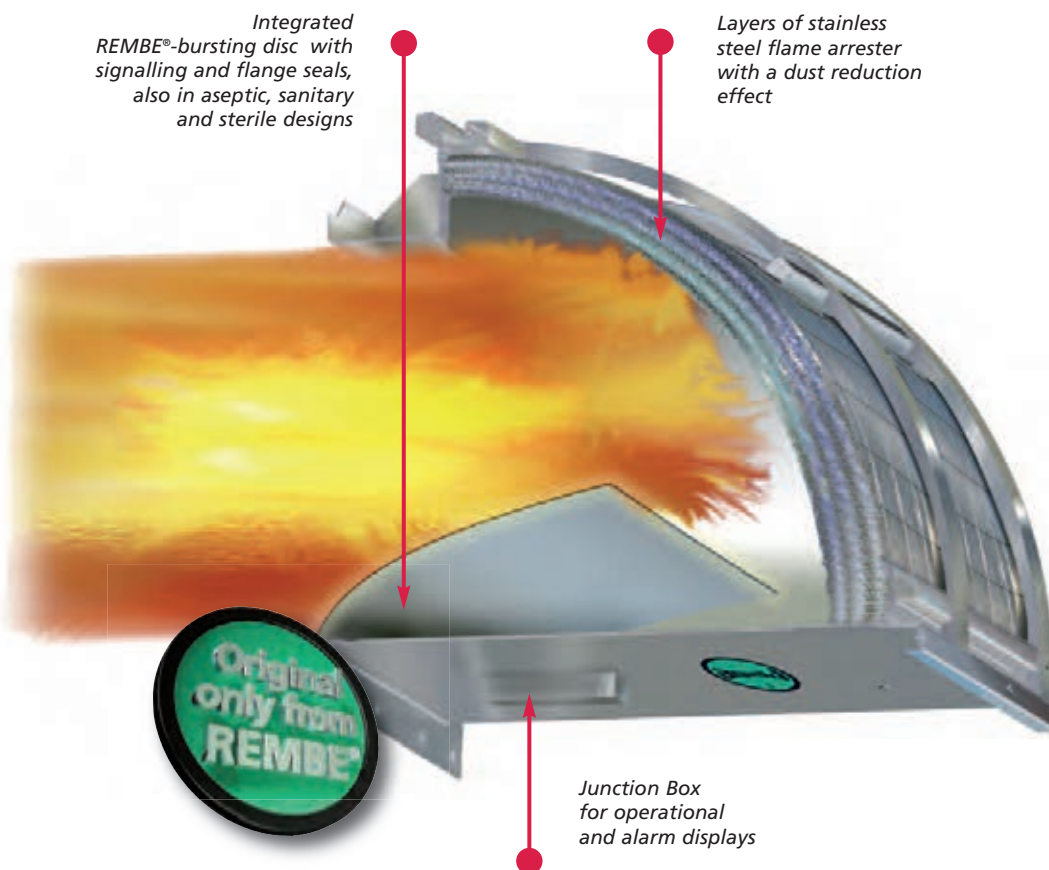

Explosion isolation

Q-Bic

Plant components with constructive explosion protection regime are often interconnected via big pipes or rectangular shafts with further apparatus. If these pipes or shafts convey combustible dusts or bulks the single apparatus have to be isolated against explosions. This way the explosion spreading in further plant components is prevented as explosions are forwarded by flames but not by shock waves.

The Q-Bic explosion isolation system extinguishes the flame front of the explosion which prevents the ignition of the flame jet with pre-compressed pressure in further apparatus. Compared with other systems, e.g. explosion barrier slide valves, the operational cost are considerably lower.



EXKOP® II

The EXKOP® system provides safe, economic and easy explosion, spark and flame front isolation. The quench valves protect interconnected equipment by high speed closure of a fast-acting rubber hose. The valve is triggered by any signal available. The complete system is failsafe due to an integrated pressure storage tank and a self-monitoring controller. In case of explosion, plant personnel can reset the EXKOP® system quickly and easily after inspection. Plant downtime is reduced to a minimum.



EXKOP® MINI

The EXKOP® MINI has especially been developed for applications with 1-2 pinch valves. Two separate inputs (burst panels, Q-Rohr®, spark detectors, etc.) can be combined with two QV II valves. The use of the system is one-button simple and is designed for easy handling.

Q-FlapCompact II / Q-Flapcompact II Plus

With the non-return explosion valve series Q-FlapCompact II, explosions in virtually all industrial sectors can effectively be isolated. The Q-FlapCompact II is certified as a autonomous protective system according to EU guideline 94/9/EC (ATEX 114) and is approved for decoupling enclosures containing organic and inorganic dusts.

The Q-FlapCompact II is suitable for horizontal aspiration lines with a max. K_{St} value of 300 bar (4,350 psig) x m/s and 0.7 bar (10.15 psig) excess pressure.



Explosion suppression



Q-Bic

Plant components like silos, mills, filters, collectors, mixers or dryers, in which combustible dusts or bulks are processed, conveyed or stored are hazardous in case of sufficient fine dust. If ignition sources cannot reliably be excluded, constructive and efficient explosion protection solutions are required.

With use of the Q-Bic suppression system the starting explosion is rapidly detected by the redundant p-RED detectors and the explosion flame is extinguished due to the prompt blowing out of dry powder in the endangered area. It extinguishes the explosion at the point of ignition. The explosion cannot be discharged to the outside atmosphere. Q-Bic is especially suitable for applications with toxicant materials, which might not be released in case of explosion.

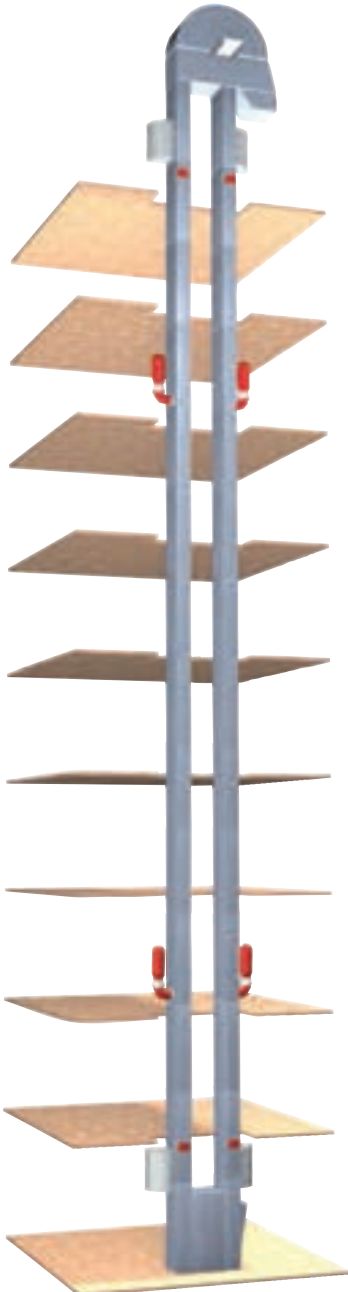

Explosion Protection for Conveyor Systems

ElevatorEX® II

The improved explosion protection system of ElevatorEX® II for bucket elevators, drag conveyors and transportation systems distinguishes itself by combining a variety of different proven features.

Critical components on the elevator's foot and head are protected by maintenance-free relief devices such as Q-Box II or bursting discs. Infrared detectors sense possible ingress of a flame front into the elevator shafts, feed openings or discharge chutes. Extinguishing barriers are activated within milliseconds at fixed points.

Plant downtime is minimised while maximising protection of the conveyor from disastrous dust explosion consequences with a minimum of investment.

The ElevatorEX® II is the only globally certified protection system for conveyor systems.

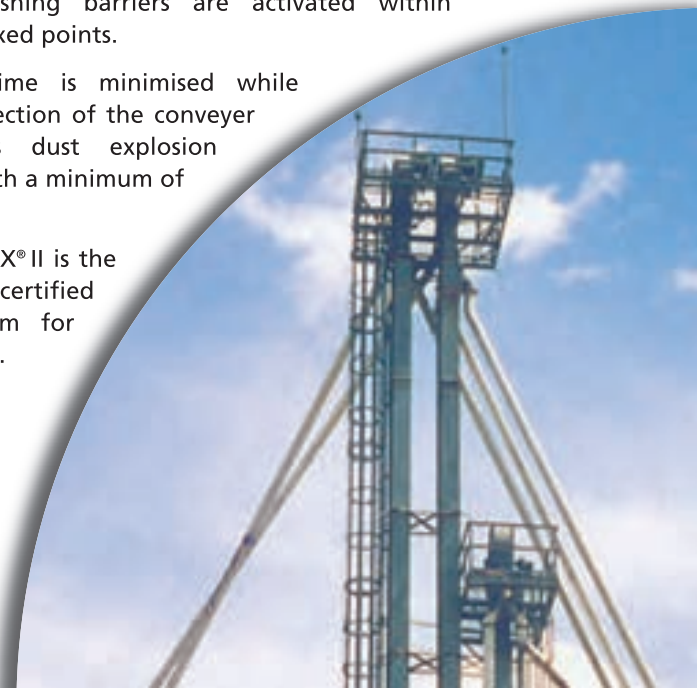

Flow Metering of Bulk and Solids



Herbert Müller
Technical Sales Control Division
herbert.mueller@rembe.de
T + 49 (0) 29 61 / 74 05 - 513
...since 1981 at REMBE®



Easen Kandasamy
Technical Sales Control Division
easen.kandasamy@rembe.de
T + 49 (0) 29 61 / 74 05 - 522
...since 2012 at REMBE®



Eugenia Nickel
Business Development Manager
Eastern Europe
eugenia.nickel@rembe.de
T + 49 (0) 29 61 / 74 05 - 114
...since 2001 at REMBE®



Anna Zwetich
Sales Assistant Eastern Europe
anna.zwetich@rembe.de
T + 49 (0) 29 61 / 74 05 - 126
...since 2012 at REMBE®

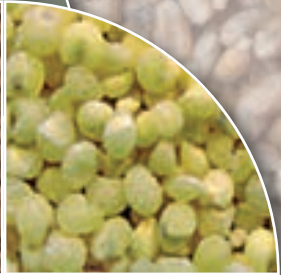



C-LEVER® *direct*

In close cooperation with the university of applied science in Düsseldorf, Germany, the C-LEVER® measurement procedure has been optimised to be an extremely precise and reliable measuring system for bulk and solids. The measurement procedure is unique in the world (patent pending) and is based on centrifugal force.

The C-LEVER® *direct* flow meter is characterised by extremely high measurement accuracy. The various series are suited to the widest variety of applications - from truck pre-loading to controlling and dosing tasks in the bulk goods processing industry. The compact design and the low overall height enable space-saving applications while reducing time during installation.

The C-LEVER® - principle is based on the laws of centripetal force. We have used this principle for the development of a very accurate, bulk density-independent, friction compensated process. An accuracy of up to 0.2 %* can be achieved even with completely different properties of bulk goods.

* All specified accuracies are related to the full scale reading at calibrated flowrate.

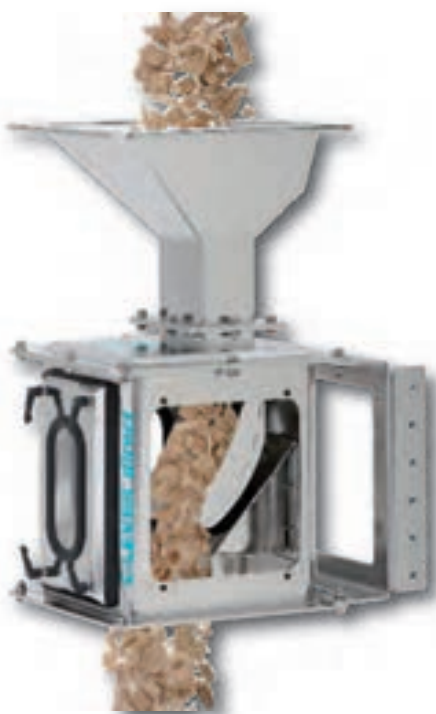

Flow metering for any application



CLD HeavyDuty (HD)

...for flow rates from 50 m³/hr to 600 m³/hr

...specifically for the measurement of bulk and solids with very high flow rates, e. g. for truck pre-loading or for incoming goods inspections. Trucks are loaded and/or unloaded with high accuracy.

CLD Precision (PRE)

...for flow rates from 50 kg/hr to 50 m³/hr

...specifically for the measurement of bulk and solids in the fields of flow metering, filling, dosage and/or controlling.

CLD FoodPharma (FP)

...for flow rates from 50 kg/hr to 50 m³/hr

...specifically for the measurement of bulk and solids in food, chemical and pharmaceutical industries: Quick and easy cleaning in case of product change. Product contamination is prevented.

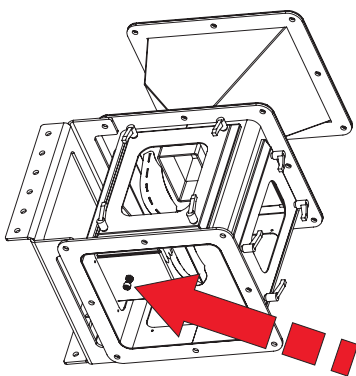

Combined transport-
and overload safety
lock which is easy
to attain

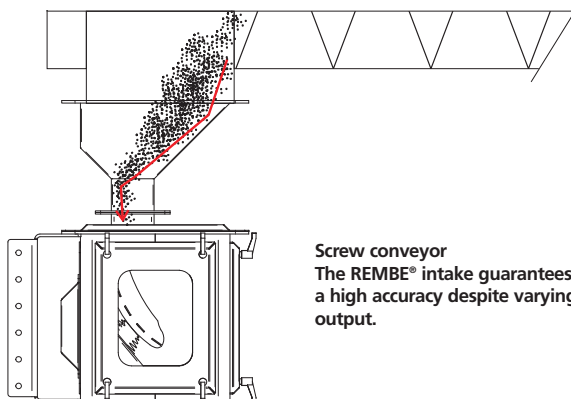

Screw conveyor
The REMBE® intake guarantees
a high accuracy despite varying
output.

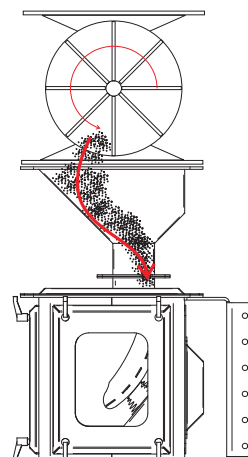

Rotary valve
C-LEVER® *direct* improves the
efficiency of the product stream.
The performance of pulsating
product streams is detected
with high accuracy.



Detection of pneumatic or gravimetric conveyed bulk and solids

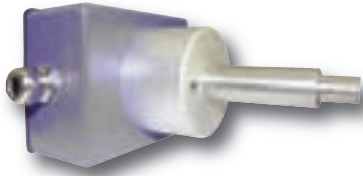

MicroFlow Sensor

MicroFlow

The MicroFlow sensor reliably detects pneumatic or gravimetric conveyed bulk and solids in horizontal and vertical metallic pipes.

The sensor uses microwaves at 24.125 GHz with less than 5mW transmitting power. It is flush mounted via a 1/2" screw thread at the pipe wall. At its front side it transmits a measurable frequency. From the reflected signal the mass flow rate is directly detected and is read out as an analogue signal proportional to the mass flow rate.

The MicroFlow is unaffected by temperature and pressure. It provides accuracy from 2 % to 5 % independent of installation position and flow profile of particles.

Conveyor belt weighing system for stationary applications

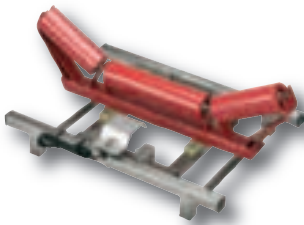

Stainless steel weighing frame

UNIBAND®

Measuring and controlling the product flow in the mining industry (gravel, sand, chalk or recycling material), are only a few of the wide range of applications for the single idler belt scale UNIBAND®. It distinguishes itself by the stainless steel weighing frame and the fully encapsulated, laser-welded strain gauge transducer. The unique design is extremely suitable for safe operations under the worst ambient conditions. This system offers the highest accuracy and reliability.

The weighing frame simply replaces the existing idler. The microprocessor controller provides all necessary features requested by belt scale users. The combined weighing accuracy of the belt scale with belt speed tachometer is $\pm 1\%$ to 2% of the measuring range.

The UNIBAND® 902-Tandem belt scale offers an even higher accuracy of 0.5% of 1% of the measurement range.



EVA High End
Control Measurement System

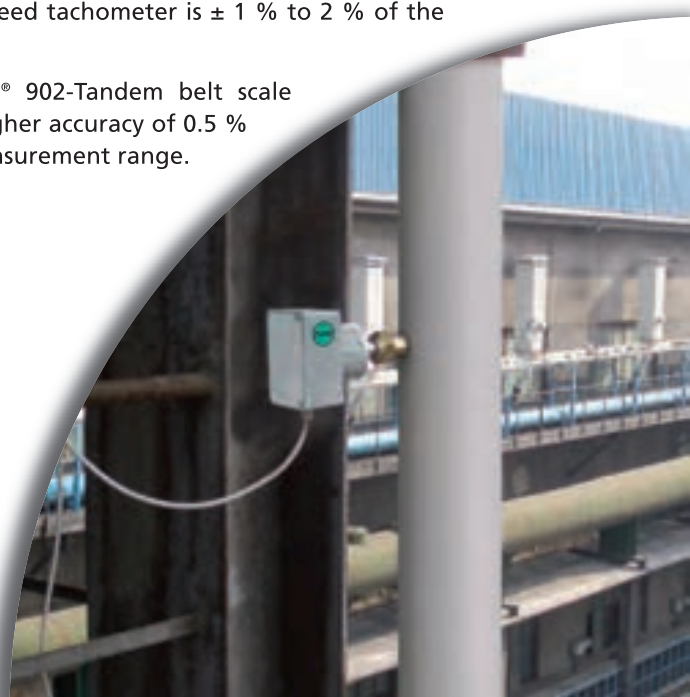

Wireless measurement of forces and weights at any place

AXIS-LOAD®

For the first time, in the fields of production and quality control, forces and loads are directly measured and their origin is identified. The data are transferred to the computer network and the results are directly processed.

The operator benefits from reduction in time and costs. On the other hand, control becomes profitable even there where systems – installed on site – are not used due to high costs.

The function is easy. The data are directly picked up in the axles, digitised and recalled via a handheld device. The point-to-point connection codes any measured value between scale and handheld device. This feature plus the clear identification of the values provides a calibratable version.

The measurement operates in a frequency range without approval. Due to the specially-developed tiny chips of the weighing and remote technology, even small axles can be used. The extremely low-power consumption assures very good recharge cycles.

The transfer of bar code data or the extended RFID technology is actively linked with this system. Suitable software programs – custom-designed to the particular application – quickly transform this system to an entire control system for production and logistics.

This mobile force and load measurement is utilised if forces and loads have to be measured independently from power supply and site (elevation, conveying and transportation technology). It is even possible to equip rotating applications (wire, rope, cable and conveyor belt technology).



...wireless weighing of axles for various applications

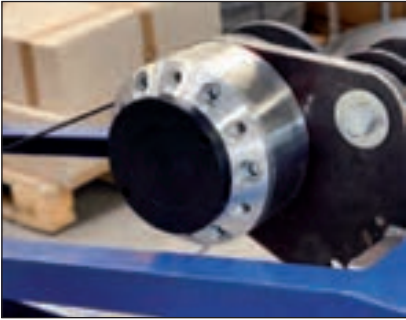

... in rope twisting machines

The modern way of measuring forces and transmitting them wirelessly to any remote PC can now be realised even in rotating applications. Quality assurance can rely on recording and evaluating all required data. At the same time complete documentation is made. The use of grinding rings is no longer necessary.

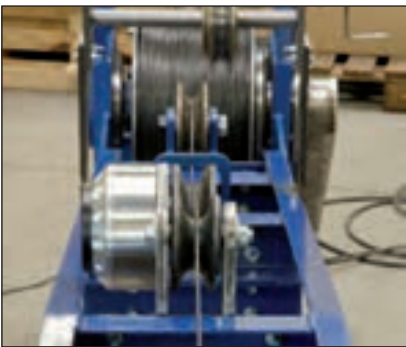

... in lifting and conveyor industries

Load sensors without figure display are used in crane scales. By means of the handheld device, all data are readable and stored as well. The wireless transmission to the remote PC is realised by connecting it with the docking station.

Metering rolls provide the measurement of throughput rates and weights in conveyor belts. The load sensors can be installed at any place in the roller conveyor (from roll diameter of 45 mm).



... in transport industries

Metering rolls and wheels improve the use of tiering trucks in in-house logistics. Due to wireless transmission and PC software, load platforms now contribute to reducing costs in the stock management. The in-house inventory control is speeded up by the mobile scale.



Electrostatic Grounding – Safety during Loading and Unloading of Combustible Materials



Corc Bahcecioglu
Sales Assistant
Sampling / Electrostatic Grounding
corc.bahcecioglu@kersting-ind.de
T +49 (0) 29 61 / 74 05 - 304
...since 2012 at KERSTING



KERSTING GMBH
SAMPLING+GROUNDING

The industry's requirements concerning safety and quality are continuously increasing. Industrial processes are complex and require an exact supervision of quality throughout the different production steps. At the same time, they are sensitive to disturbance. Safe processes assure efficient production. Quality control enhances customer confidence, avoids waste and additional costs.

For more than 10 years, KERSTING has been concentrating on the fields of explosion prevention and sampling. Customers can now rely on special technique both, in the fields of explosion prevention in the sense of electrostatic grounding and sampling of bulk and liquids.



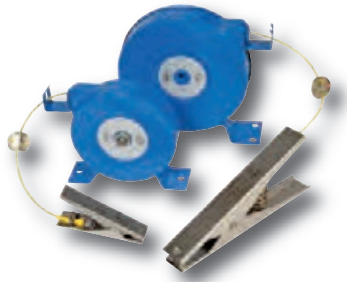

Discharge Reels, Grounding Clamps & Cables

When you have to bridge distances, it is ideal to use discharge reels. They are equipped with a yellow Hytrel-coated steel cable in different lengths. If requested, the reels can be delivered assembled with a grounding clamp.

All KERSTING grounding clamps are especially made for electrostatic grounding. They have sharp teeth which guarantee a good contact even through isolating paint layers on drums and machines or when biting through dirt, rust, grease, etc. This way they assure an effective metal-to-metal connection. The grounding clamps can be delivered assembled with a cable reel or with a straight or spiral cable in different lengths.



Ground Monitoring

Farado®

In order to prevent the accumulation of static electricity, the Farado® grounding system verifies that the correct connection to ground is performed before starting the loading procedure. This way, dangerous situations due to failures and human errors can be avoided. The device is connected to a mobile tank through a bipolar clamp and a cable. A reel with 10 meters (393 inches) of cable is also available.



Metering Devices

Coulombo

The new manual coulombo meter, Coulombo, has been developed together with leading experts in the area of Electrostatics. It is suitable for determining the ignitability of electrostatic discharges such as brush discharges or sparks up to 200nC, for instance, on plastic surfaces, at RIBCs, FIBCs and on electrostatic spray systems.



MegaSafe ISO 1Ex

Easy to handle, intrinsically safe high ohm isolation tester for ex areas up to 2 TΩ with test voltages, selectable 32, 100 or 500 V. The MegaSafe is ATEX approved for Ex II areas. It is suitable for applications like testing isolation at cables and electrical devices, testing bleeder resistors against static charge or testing antistatic surfaces.



Non-jamming Sampling System



Felix Obermeyer
Sales and Business
Development Manager
felix.obermeyer@kersting-ind.de
T +49 (0) 29 61 / 74 05 - 301
...since 2007 at KERSTING



Burkhard Hansmann
Sales Engineer
Sampling / Electrostatic Grounding
burkhard.hansmann@kersting-ind.de
T +49 (0) 29 61 / 74 05 - 303
...since 2010 at KERSTING

SamFreeglide™

The secret of the SamFreeglide™ is the flexible diaphragm that keeps the powder away from the working mechanism of the sampler. By keeping the mechanism clean, the sampler will not jam in operation. Furthermore no impurities from the mechanism will contaminate the product. The SamFreeglide™ can be installed in down pipes from DN 100 to DN 400 (4" to 16").



Sampling Systems

...for powders



UDS Pharma Picker

Unit Dose Sampling (UDS) is a sampling method which applies for pharmaceutical production. With this method, the "Content Uniformity" is proofed and assured. The UDS Pharma Picker is an internationally approved standard for powder samples from 0.1 to 2.5 ml.

... for liquids in tank storages



for liquids in tank storages

The dip bottle is used for layer sampling of tank storages and big vessels. The device draws specific samples from the requested depths and is manufactured from high-quality polished stainless steel. The dip bottle with its sample volume of 1 liter is lowered into the liquid and is opened at the point where the sample is drawn.

...for downpipes, silos and conveyor lines



Inline sampler

The auger sampler can be built in non-pressure applications such as vessels and downpipes. It is suitable for the food and pharmaceutical industries and allows continuous sampling of any volumes out of the product. The sampler is especially designed for hard flowing materials and for those one forming lumps

SiloTasty & InlineTasty

With the new, manually operated Inline Samplers Silo Tasty and InlineTasty it is now easier than ever before to take a sample from a down pipe, silo or pneumatic convey line. The Tasty is operated with a handle and is the ideal solution for operators and planners with small budget.

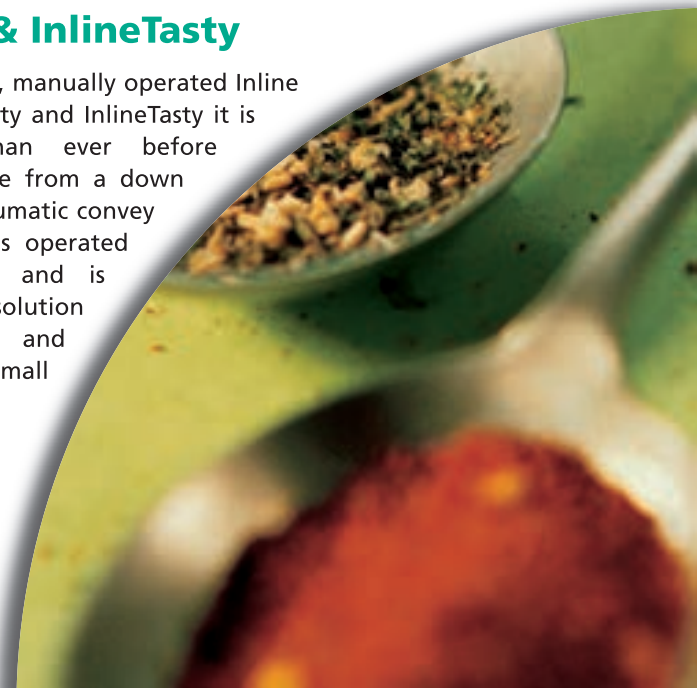

Monitoring of Screws and Screw Connections / Flange Connections Diagnosis

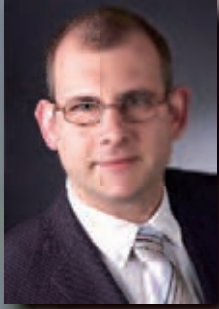

Thomas Haas
Managing Director
thomas.haas@rembe.de
T +49 (0) 29 61 / 74 05 - 350
...since 2012 at
REMBE® FIBRE FORCE GMBH



Max Egen
Technical Sales
max.egen@rembe.de
T +49 (0) 29 61 / 74 05 - 351
...since 2009 at
REMBE® FIBRE FORCE GMBH

Threaded joints guarantee function and safety in industrial applications as they connect components sturdily and permanently. The required torque on the bolts is controlled and adjusted to date with a torque wrench. This method still leaves a large area of uncertainty as to which friction influences appear between the threads and between the nut and washer.

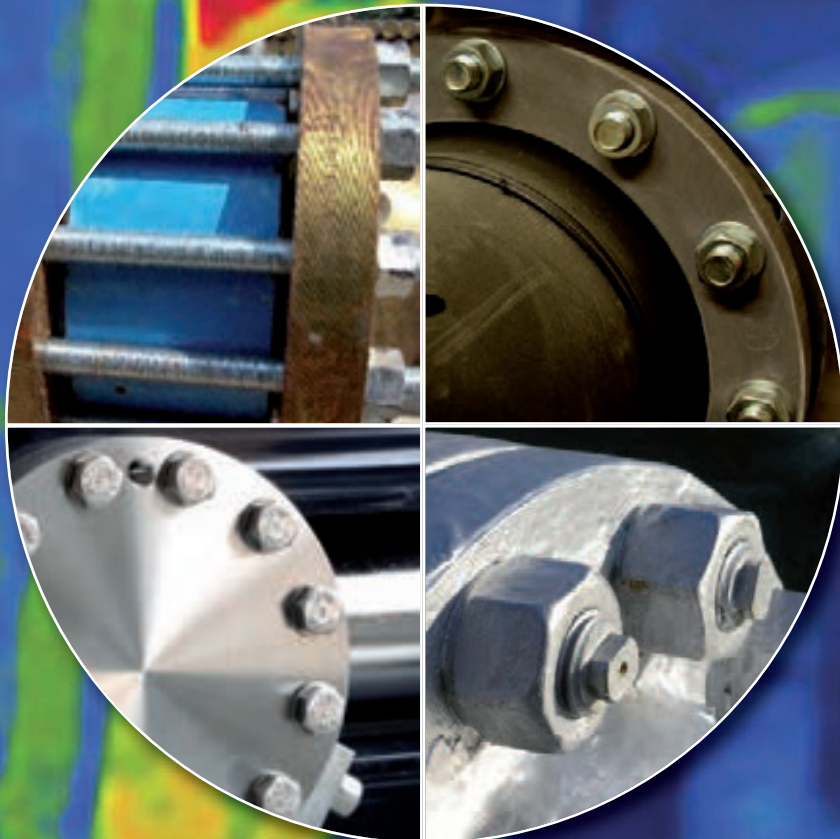

REMBE®
FIBRE FORCE GMBH

The company develops, manufactures and markets fibre optic products for sensor purposes. The fibre optic measurement of temperature, pressure and material strain is applied when standard measurements do not supply satisfactory results - due to inevitable electromagnetic interferences or extreme operational conditions.

Intrinsically safe pressure load detection

SPASS®-Dremodisc

The SPASS®-Dremodisc equipped with a special plastic optical fibre uses side pressure sensitivity of the optical conductivity for the detection of the true pressure load on the surface of the washer in a bolt and nut/flange connection.

The SPASS®-Dremodisc simply replaces the existing washer. The wireless transfer of readings to the smart wrench display ensures the expected ease-of-use. The smart wrench has a clearly readable display which shows individually the exact tensile tension and reports when a pre-configured limit is reached. There are also optional interfaces. They make it possible to access available computer networks which provide huge advantages, especially for quality and/or operation management.

The SPASS®-Dremodisc press sensor with its low installation height is typically applied in or around places of difficult and awkward access. It is designed for a maximum pressure load of 500 tons and for temperatures of up to max. 300 °C (572 °C). No electricity is required at the point of measurement.



SPASS®-Dremodisc „Eco“



SPASS®-Dremodisc press sensor

Fibre optical measurement bolt

MoniBolt

With the innovative fibre optical sensor screw MoniBolt, the new pre-load sensor for bolts, the pre-load of pre-stressed bolt material between two clamping points is detected.

An optical fibre, embedded inside of the bolt body and provided with a so called Fibre Bragg Grating (FBG), generates a precise optical signal in accordance with the current pre-load. The appendent optical/electrical conversion and evaluation unit converts this optical signal into a standardised electrical signal and provides it at its output port.

The MoniBolt sensor screw simply replaces the formerly used bolt without a loss of consistency compared to a common bolt. A fibre optical cable is connected to a coupling port placed at the screw head, connecting the evaluation unit to the sensor.



Fibre optical sensor screw „MoniBolt“ with integrated optical coupling port

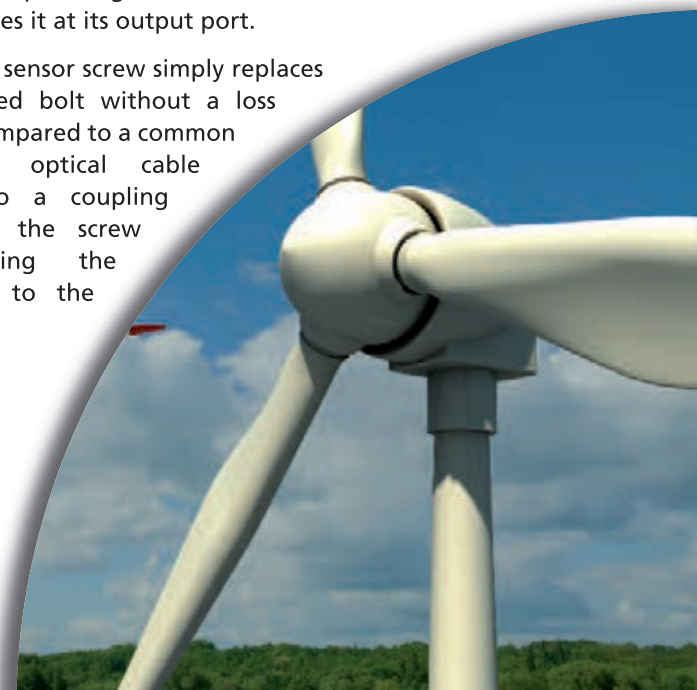

Monitoring of sealings

MoniSeal

Using the new fibre optical sealing system MoniSeal, for the first time, it is possible to detect the real load pressure in flange connections which are relevant to safety. This way their tightness is guaranteed.

Four independently-operating fibre optical pressure sensors inside the MoniSeal provide a reliable detection of critical working conditions. The MoniSeal is designed for operating temperatures of up to 300° C (572° F) - higher temperatures on request. By reading four sectors, the operator is informed about the average value of the real pressure load in total as well as about too low or too high load pressure in single sections.

A reading unit detects and stores the corresponding values. It indicates - acoustically and optically - both, falling below and exceeding of programmable values. Optionally, the forwarding of the data for further electronic data processing is possible.

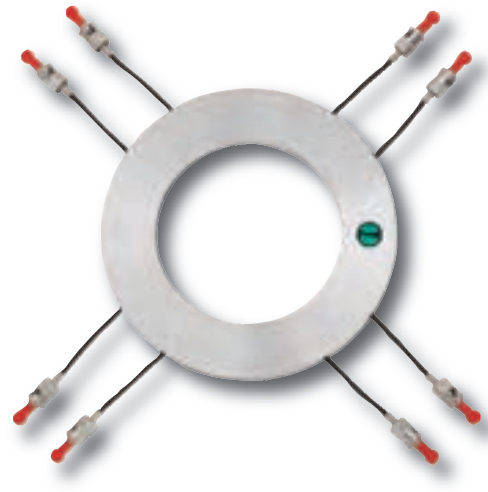

Fibre optical sealing system
MoniSeal

Access control, premises supervision and assets protection

ArgusLine

A side pressure sensitive fibre optic cable modulates its light transmission properties according to the side pressure applied. An optoelectronic converter and evaluation module perceives the fibre optical signal and generates a free programmable, electrical alert signal. Selecting the suitable parameters, changes in side pressure from a few grams up to several tons can be detected and stored.

Both, the protection of exhibits (museum, galleries, exhibitions, etc.) and persons (especially in case of underground installation of the line sensor) are possible. Due to the deployment of totally metal-free components, the ArgusLine fibre optical sensor system is not detectable.

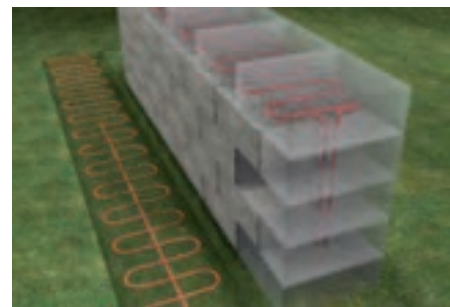

Fibre optical Sensor System
ArgusLine



Intelligent Solutions from our Specialists in the REMBE®-NETWORK

Booklet of Safety + Security

This booklet gives you basic knowledge to the subject of „**Dust Explosion Protection**“ as well as useful information about efficient and cost-saving plant protection.



Please download at www.rembe.com or call for: T +49 (0) 29 61 / 74 05 0

Unique experience in applications combined with technical know-how: Since 1973 our highly qualified team of experts has given you the safety when planning and carrying out your explosion protection concept.

1. On site consultation

After having visited the production line at your company our specialists will work out an appropriate tailor-made concept acc. to your requirements. REMBE® engineering relishes an excellent reputation worldwide.

2. REMBE® Technical Seminars

We offer basic and detailed training in pressure and safety protections systems including live demonstrations for up to 200 participants at a suitably insured site of a clients choice.

3. Optimised process safety leading to big cost savings

You reduce your insurance payments by implementing a comprehensive safety concept. If you intend to invest in the safety of your plant our experts will advise you.

4. Active cooperation in international standardisation committees and boards

We continuously introduce our knowledge and innovative ideas into European and international boards, such as CEN, NFPA, VDMA, ESMG, INDEX, WJI, VDI, IFF, EHEDG, vfdb, MHEA, SHAPA, FSA, DIERS, DSIV.



REMBE® GMBH
SAFETY+CONTROL



KERSTING GMBH
SAMPLING+GROUNDING



REMBE®
FIBRE FORCE GMBH

Gallbergweg 21
59929 Brilon / Germany
T+ 49 (0) 29 61 - 74 05 - 0
F+ 49 (0) 29 61 - 5 07 14
sales@rembe.de
www.rembe.de



REMBE